

52.572

Viewmate monitor arm - ceiling 572

Use this ceiling mount to attach two flat screen monitors to a ceiling. Used for terminals, information points, point of sale systems etc. One of seven height presets can be set during installation. Afterwards, the height is easily adjusted and fine-tuned using the clamp lever.

- Static height adjustment range of 600 mm
- Fixed depth
- Main components made of steel
- VESA MIS-D 75 x 75/100 x 100 mm compatible
- Rotate 360°, tilt +90°/-90°, swivel 360°
- Weight capacity max. 15 kg per monitor
- Comes with a ceiling mount
- Monitor size limit: height 1104 mm
- Easy to adjust in height using a clamp lever
- Comes with all necessary fasteners

viewmate ^x

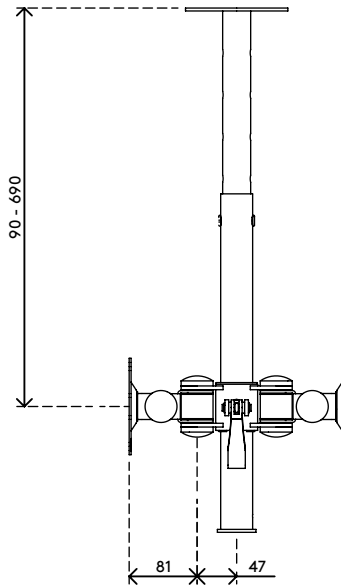
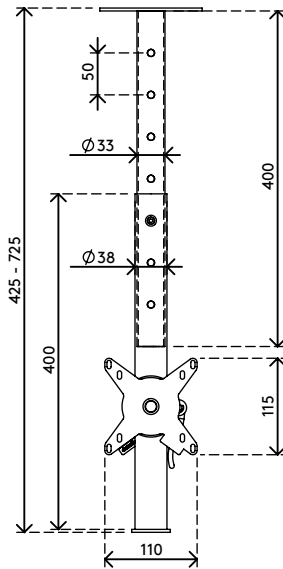
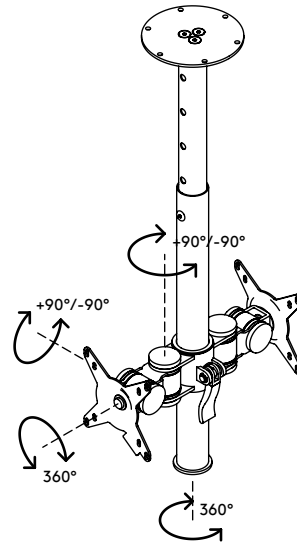
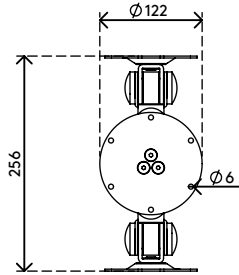

600 mm (23,6")

+90°/-90°

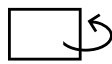

+90°/-90°



360°



1104 mm (43,5")



75 x 75/100 x 100



(2x) 15 kg

Viewmate monitor arm - ceiling 572

2016/03/25

52.572

530 x 185 x 135 mm

1 pcs

silver

3,6 kg

805410525729