

58.102

Viewlite monitor arm - desk 102

The proximity of monitor and pole makes this is an ideal, compact POS (Point Of Sale) solution. Stepless height adjustment lets each user find their own optimal ergonomic position. Cables are easily hidden in the aluminium pole to create a tidy, professional impression.

- Static height adjustment range of 350 mm
- Fixed depth
- Integrated cable management
- Main components made of aluminium
- 40% of aluminium content is already recycled
- VESA MIS-D 75 x 75/100 x 100 mm compatible
- Rotate 360°, tilt +65°/-65°, swivel 360°
- Weight capacity max. 8 kg per monitor
- Comes with a desk clamp mount and bolt-through desk mount
- Suitable for a desktop thickness of 5 up to 40 (clamp) or 50 mm (bolt through)
- Monitor size limit: height 816 mm
- Fitted with a practical quick-release VESA system
- Monitor rotation lock can be enabled

viewlite

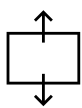
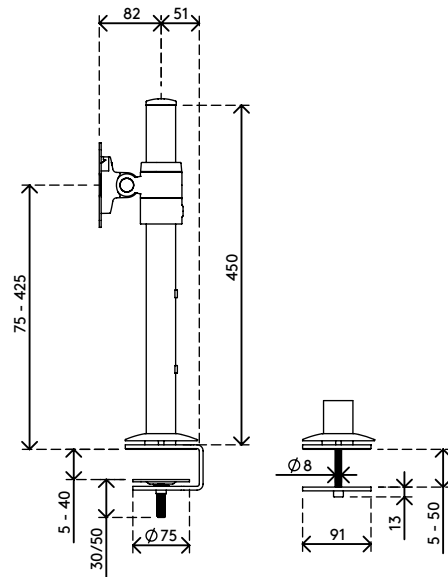
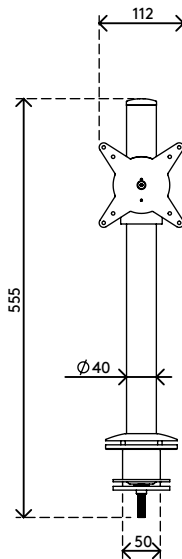
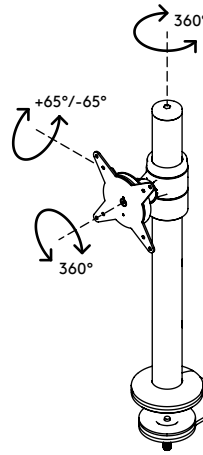
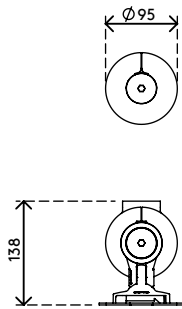

350 mm (13,8")



+65°/-65°

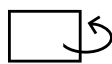

360°



360°



816 mm (32,1")



75 x 75/100 x 100



8 kg

Viewlite monitor arm - desk 102

2016/03/25

58.102

 610 x 180 x 120 mm

 1 pcs

 silver-white

 3 kg

 805410581022

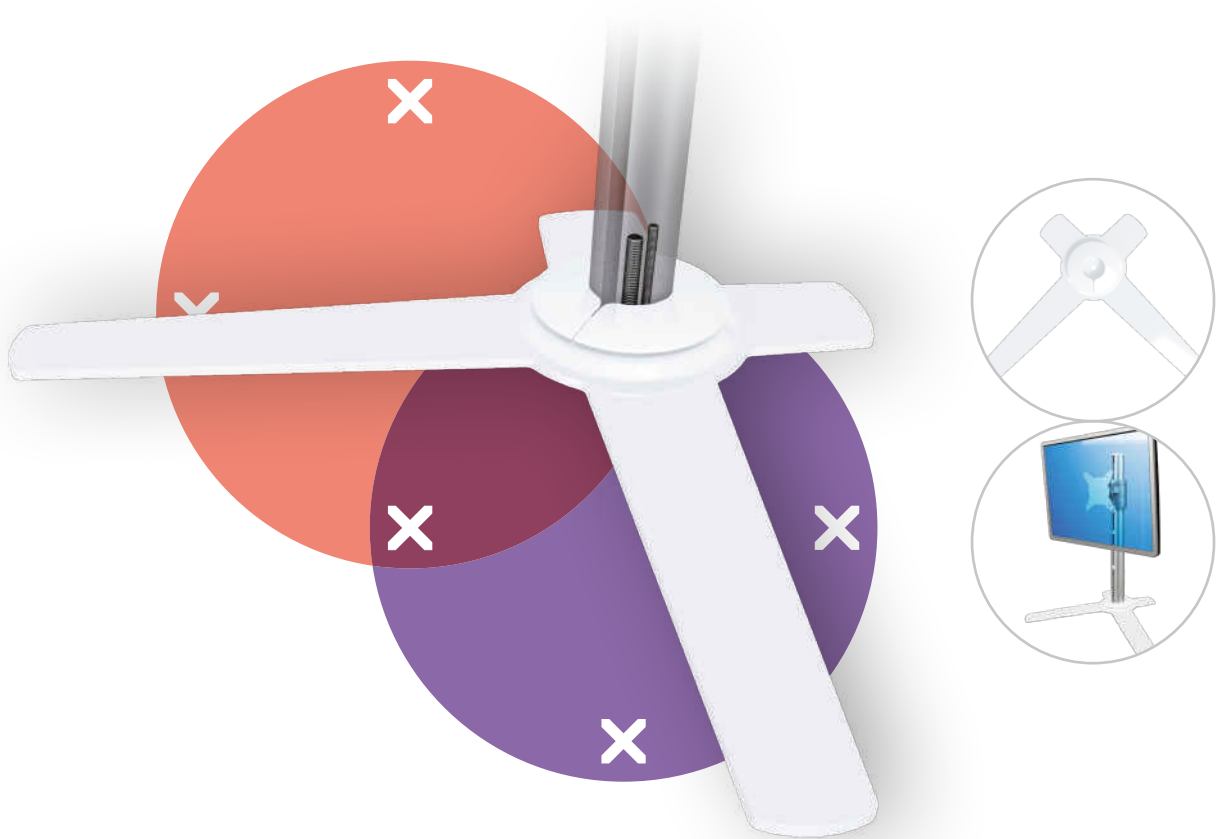

58.010

Viewlite desk plate - option 010

Specifically designed for the 'Viewlite monitor arm - desk 10', this solid steel free-standing desk base is the perfect solution to help create a truly flexible workspace.

- Desk plate for Viewlite monitor arm - desk 102
- Dimensions (w x d x h): 439 x 318 x 28 mm
- Comes with all necessary fasteners
- Made of steel

viewlite

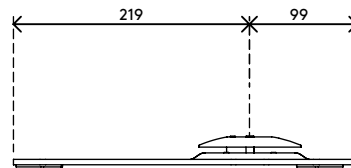
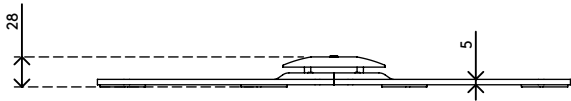
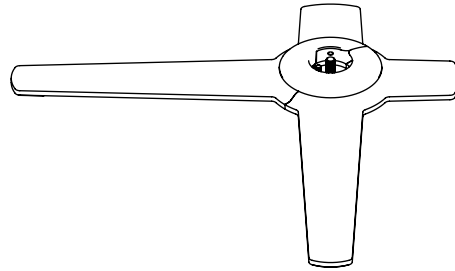
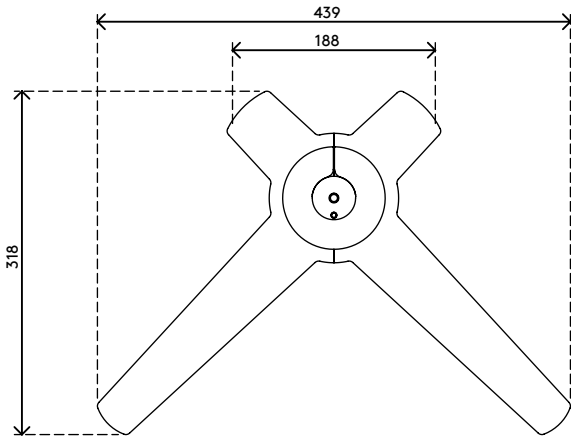

Viewlite desk plate - option 010

2016/03/25

58.010

 442 x 248 x 70 mm

 1 pcs

 white

 2,3 kg

 805410580100