

edbak

ProAV Mounting Solutions



PROAV MOUNTING SOLUTIONS

page

10

Video Walls



page

14

Video Led Walls

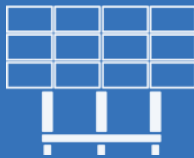

page

16

Menu Boards



page

18

Video Conference Trolleys

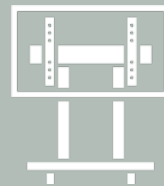

page

22

Stands





page

24

Window Facing
Display Mounts



page

26

Monitor
Mounts



page

30

Projector
Mounts



page

32

Kiosks



page

34

Bespoke
Solutions



www.edbak.com

Leading Products

						
VWTA2257-L	VWPOPT65	VWPOP65-L	VWLTA Series	MBV2147-L	TRV100	TRV200
						
TRF100	TR5	VCTX190	TRV400	TR5E	CHV4	CH4
						
TRMV1	TRS4	STD17	STDV100	MWDC	PWB1	XWB1
						
FSM100	FSM150	VSM653	VSM654	RMSA1	GD04	GDV121
						
PMV400	PMV100	PMHD115	POK100/POK101	OWM100/OWM101	IDS5507	

Screen Size	Swivel	Distance from Ceiling	Mounting Pattern	Tilt	Height Adjustment	Maximum Load	Distance from Wall	Landscape to Portrait
								

Edbak Core Values

We respect every employee and customer. We take time to listen carefully and talk like partners. We support each other and play in one team with a common goal in mind. In this synergy, we act in an organised, coherent and efficient manner. We enjoy working together and succeeding together - that is how we achieve a strong leadership position and become a dynamically recognisable brand in the market.

partnership

engagement & responsibility

We involve staff in decisions concerning the operation of the entire production site. Each employee takes responsibility for actions within their area of responsibility (extreme ownership). This translates into greater commitment and motivation - as a result, employees participate proactively in the genuine development of the company.

We strive to be a creative and innovative organisation in terms of the products and solutions offered. We make every effort to ensure that our production technology is of the highest standard and that the company is managed in an ethical, economical and modern way. We create useful products and solutions that connect people with technology. We support the future.

creativity & innovation

improvement & development

We have been continuously perfecting the craftsmanship that triggers so many challenges to the industry. It's been 32 years. We are constantly looking for new ways to train our employees diligently and optimise our production processes. We are strong locally and recognised globally. This fills us with pride and humility. We look for new markets and develop new products. We invest in modern technologies while keeping tradition in mind.

We pursue our goals and conscientiously adhere to agreed rules. We always treat other people, colleagues, customers and suppliers with respect. We are aware that a company is made up of people, which is why we make sure that everyone in the organisation is in their rightful place feeling indispensable. This approach integrates and engages the entire plant community and, in the eyes of our business partners, we are a reliable manufacturer and provider of excellent solutions.

professionalism

WE ARE

EDBAK is a Polish, family-owned company – manufacturer of mounting systems. The company was founded in 1992 and has been the expert in metal manufacturing ever since. Also, EDBAK has been a leading European manufacturer of AV solutions ranging from display mounts, wall brackets, conference trolleys, stands, desktop monitor mounts, dedicated systems for LED, video wall mounts, and info kiosks. All items are made in Poland.

The company is distinguished for focusing not only on selling standard, ready-made solutions but also on providing products that meet the requirements of the end customer through the investments of business Partners and integrators. EDBAK does its best to deliver added value, making sure all products are safe, durable, quick to install and ergonomic. By choosing EDBAK you can be sure to receive superb pro AV mounting solutions.

You have our support from the start. For 32 years.



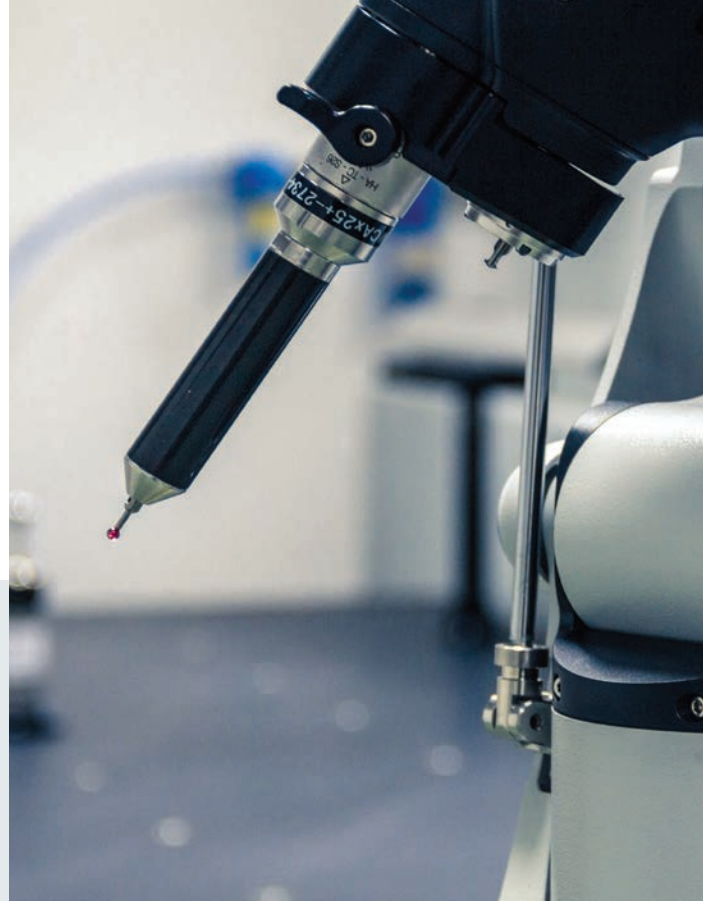

Made in Poland

We design and make all of our products here in Europe ensuring that both quality and design reflect our common heritage and culture. Our EDBAK Research and Development office can provide more appropriate and more timely response to your needs for customization as well as for products. And the shipping is easier, faster and safer when you know it is coming from central Europe.



AVIXA Silver Member





Digital Signage



Education



Transportation



Hospitality



Industrial



Staging



Offices



Broadcast



QSR & Restaurants



Healthcare



Conference Rooms



Retail

Markets

Whether you are a corporation, institution, government or small business (or a systems integrator that serves the AV industry), EDBAK is here to help you. Almost every company can find a use for the newest displays and applications from customer friendly videowalls to wayfinding kiosks to an information board in a lobby. EDBAK offers solutions with European style and strength to mount, stand, move, and hold up displays of all sizes and shapes

• **NORTH AMERICA**
USA

• **EUROPE**

Austria, Belgium, Czech Republic, Cyprus, Denmark, Estonia, Finland, France, Germany, Greece, Hungary, Ireland, Italy, Latvia, Lithuania, Luxembourg, Malta, Netherlands, Norway, Portugal, Romania, Serbia, Slovakia, Spain, Sweden, Switzerland, United Kingdom

• **ASIA**

Hong Kong, Japan, Saudi Arabia, United Arab Emirates

• **AFRICA**

Egypt, Kenya, Morocco, Qatar, Republic of South Africa, Tunisia

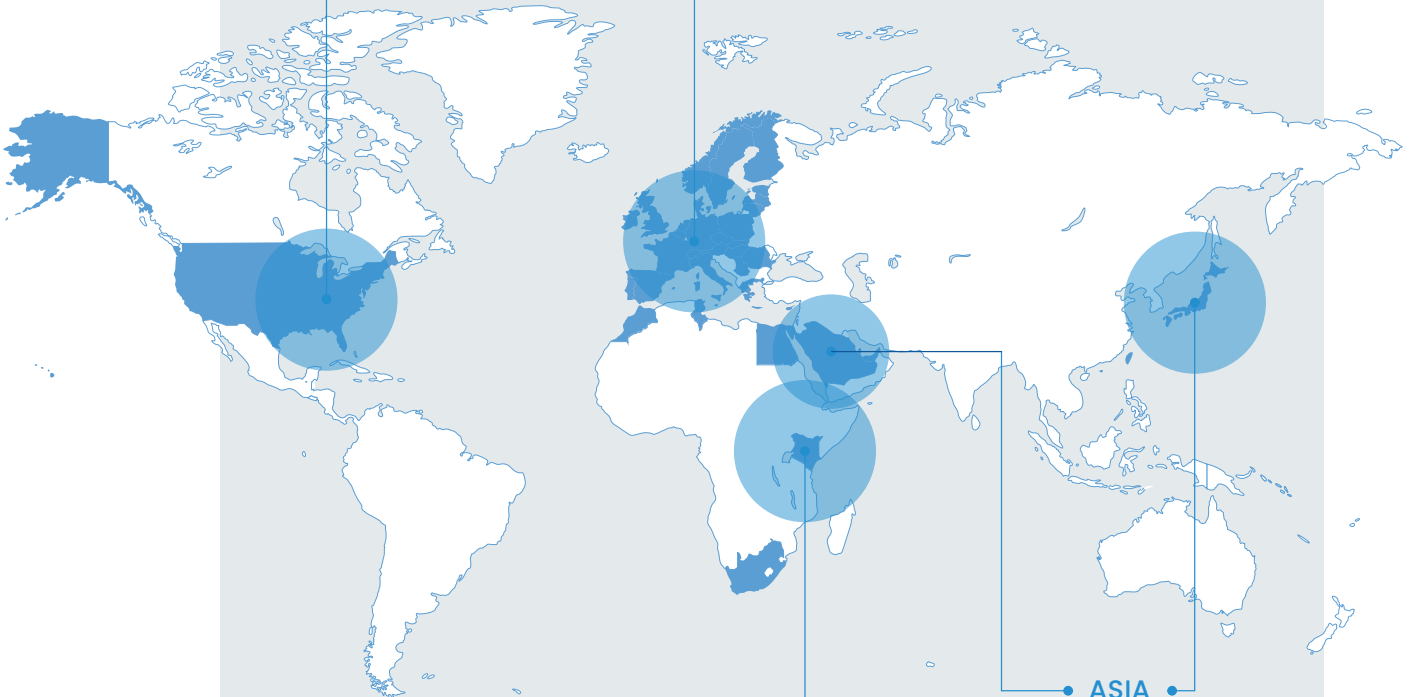



Video walls

Multi-screen video walls are ideal for places that require dynamic and effective communication with the audience.

Video walls are most often installed in public spaces: educational institutions, galleries, shopping malls, train stations, airports.

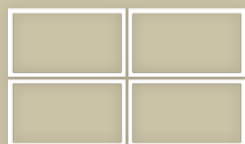

EDBAK video wall mounts and constructions are both functional and safe for users, which is confirmed by the certificates held.

VWTA Series

Mobile Video Wall Trolleys



min. 100x100
max. 600x400



49"-57"



290 kg



1. High-end quality and aesthetics
2. Durable aluminium design
3. Design for 49"-57" screens
4. Independent 8-point micro-adjustment ensures perfect alignment of screens without the use of tools
5. Integrated cable management system for smart installation
6. Computer shelf and mount featuring VESA 100×100 as standard
7. Possibility of mounting other accessories (e.g. shelves) on aluminium profile guides

Monitor Configuration	Product	Screen size	Max. capacity	Max. VESA	Weight	Dimensions (HxWxD)
	VWTA2247-L	42"- 47"	210 kg	min. 100x100 mm max. 600x400 mm	65 kg	2017x1960x964 mm
	VWTA2257-L	49"-57"	220 kg	min. 100x100 mm max. 600x400 mm	71 kg	2017x2220x964 mm
	VWTA2347-L	42"- 47"	205 kg	min. 100x100 mm max. 600x400 mm	92 kg	2617x1960x964 mm
	VWTA2357-L	49"-57"	190 kg	min. 100x100 mm max. 600x400 mm	95 kg	2617x2220x964 mm
	VWTA3247-P	42"-47"	305 kg	min. 100x100 mm max. 600x400 mm	105 kg	2017x2930x964 mm
	VWTA3257-L	49"-57"	290 kg	min. 100x100 mm max. 600x400 mm	108 kg	2017x3320x964 mm
	VWTA3347-L	42"-47"	305 kg	min. 100x100 mm max. 600x400 mm	140 kg	2617x2930x964 mm
	VWTA3357-L	49"-57"	290 kg	min. 100x100 mm max. 600x400 mm	144 kg	2617x3320x964 mm

VWPOPT65

Ultra-Thin Video Wall Pop-out Mount With Quick Release



min. 100x100
max. 400x400



42" - 65"



42 kg



1. Possible landscape or portrait setup
2. The thickness of the mount is only 60 mm +/- 7.5 mm micro-adjustment ensures smooth alignment of screens
3. Levelling screws allow adjustment of screen height
4. Pop-out system for quick and easy access for installation and servicing purposes
5. 10° tilt of the screen with the mount open increases access to the back of the screen from the bottom
6. Padlock protection against uncontrolled opening

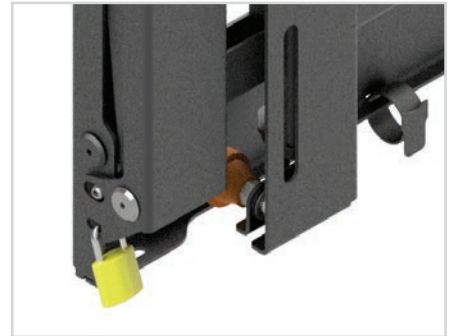
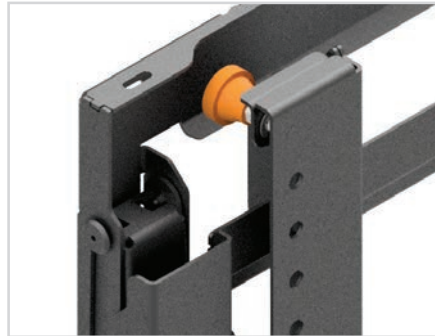

VWPOPT65 Video Wall Pop-out Mount features an additional accessory- the adapter VWRAT65 thanks to which we can increase VESA standard up to 600x400

VWPOP65-L

Video Wall Pop-out Mount With Quick Release



min. 100x100
max. 600x400



42"-65"



60 kg



1. Independent 8 position adjustment allows precise alignment of screens without the use of tools
2. The retractable mechanism provides convenient service access to screens installed in recesses and places difficult to access
3. The retractable mechanism can be secured with a lock screw to prevent the screen from being accidentally extended
4. Modular design allows the building of video walls in various configurations using multiple VWPOP65-L mounts and spacers between the modules
5. Open product design provides full access to cabling
6. TÜV tested



Video LED walls

With its modular design, our mobile constructions allow the installation of LED modules up to 350x250 cm wide. They are characterised by high-end quality and aesthetics. Durable aluminium design and braked castors ensure high mobility.

LED Trolley enjoys a great interest among exhibitors during trade fairs and conferences. The mounted accessories as computer and AV equipment shelf make this product a mobile structure suitable for places where there is a need for dynamic and effective communication with the audience, displaying and instantly updating information on the monitor wall.

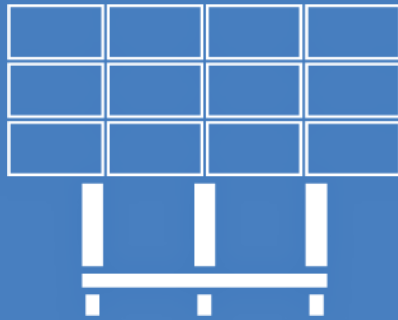

VWLTA Series

dvLED Video Wall Mobile Stands



1. High-end quality and aesthetics
2. Durable aluminium design
3. Fully customize to each LED modules
4. Micro-adjustment ensures perfect alignment of modules without the use of tools
5. Integrated cable management system for smart installation
6. AV equipment shelf included
7. Braked castors



Ceiling mount series



Floor-to-ceiling mount series



Bold Down stand series



Wall mount series

Menu boards

MBV Series is a robust and accurately manufactured ceiling mounts for multi displays installations. It features a slim structure and simple design. Stepwise height adjustment ensures accurate fastening whereas the integrated cable routing system allows the cabling to be hidden, guaranteeing aesthetic looks.

Menu boards are equipped with safety devices that protect the screen against falling, which is ideal for hotels, restaurants and public buildings. MBV mounts are a perfect solution for those who value safety, aesthetics and comfort during use.



MBV2147-L

MENU BOARD CEILING MOUNT



min. 100x100
max. 600x400



140 kg



42" - 47"



0°/+18°



1. Telescopic mount
2. Stepwise height adjustment
3. Screen load-carrying plate made of aluminium
4. Quick and simple installation
5. Integrated cable routing system
6. Universal VESA-compliant mounting range



Video Conference Trolleys

Video conference trolleys are the excellent choice for those looking for a practical solution that meets the highest expectations. They have been designed to provide comfort during a video conference, speech or public presentation. Conference trolleys are perfect for all professional applications in conference rooms, office rooms and educational facilities. They are mobile and practical in any arrangement due to their ergonomic shape and stable aluminium structure.

Videoconferencing trolleys are equipped with a system that protects the monitors against falling and ensures intuitive adjustment of screens height. AV accessories, such as a laptop or camera, can be placed on shelves that are fitted directly to the vertical column. In addition, the integrated cable management system provides smart installation and makes the finished solution look very aesthetic.

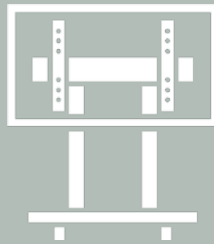

TRV100

VIDEOCONFERENCING TROLLEY
PREMIUM SERIES

1. Modern design with high-end finish
2. Stable and durable aluminium structure
3. Seamless adjustment of screen height
4. Integrated cable management system



min. 100x100
max. 900x600



70 kg



42"-75"



0°/+11°



TRV200

VIDEOCONFERENCING TROLLEY
PREMIUM SERIES

1. Modern design with high-end finish
2. Up to 75"-86" screen
3. Seamless adjustment of screen height
4. Horizontal or vertical screen installation



min. 100x100
max. 600x400



120 kg



75"-86"



0°/+11°



TRV300

VIDEOCONFERENCING TROLLEY
PREMIUM SERIES

1. Modern design with high-end finish
2. Up to two 42"-55" screens
3. Stable and durable aluminum structure
4. Horizontal or vertical screens installation
5. Seamless adjustment of screen height
6. Shelves can be fitted directly to the supporting column Simple and fast installation
7. Non-marking braked castors
8. Integrated cable management system for smart installation



min. 100x100
max. 600x400



120 kg



42"-55"



0°/+11°



TRV400

VIDEO CONFERENCE TROLLEY

1. Up to 136" screen
2. Modern design with high-end finish
3. Seamless adjustment of the screen height



min. 100x100
max. 1500x900



200 kg



100"-136"

TR5

FLAT SCREEN TROLLEY

1. Simple and fast installation
2. Aesthetic design of powder-coated steel and polished tubing
3. Adjustable height



min. 100x100
max. 600x400



80 kg



42"-65"



-6°/+9°



TR5E

CONFERENCE TROLLEY

1. Simple and fast installation
2. Adjustable height
3. Cable management system



min. 100x100
max. 600x400



50 kg



42"-65"

TRF100

TROLLEY WITH ROTATING HEAD
AND HEIGHT ADJUSTMENT

1. Rotating head allows the monitor to be rotated vertically and horizontally
2. Equipped with a shelf for a laptop or other AV accessories
3. Seamless adjustment of screen height
4. Cable management system



min. 100x100
max. 400x400

MAX KG
40 kg



55"



VCTX190

FLAT SCREEN VIDEO CONFERENCING
TROLLEY WITH HEIGHT ADJUSTMENT

1. Equipped with shelves for a camera and a decoder
2. Includes storage compartment for AV accessories
3. Fully adjustable height
4. Universal VESA-compliant mounting



min. 100x100
max. 800x400

MAX KG
80 kg



65"-98"



Video conference trolleys accessories

CHV4

Video Conferencing
Camera Holder



CH4

Video Conferencing
Camera Holder



TRSMV1

Metal Shelf
For Trv Series



TRS4

Glass Shelf
With Handle



Stands



Stand is an absolutely great solution for presenting the screen in an elegant and safe manner at the same time. Our products are universal and, due to their wide range of height adjustments, they can be easily adapted to many types of screens available on the market. A solid and stable base with the possibility to fix it to the floor makes it a perfect match to hotel lobbies, conference rooms, etc. Integrated cable management makes the finished installation neat and tidy. Above all, free standing product is a perfect choice for professional or commercial applications.



STD17

FLAT SCREEN FLOOR STAND

1. Multifunctional base for use as a stand or trolley
2. Seamless height adjustment
3. Universal VESA mount suitable for multiple screen types



min. 100x100
max. 600x400



37" - 60"



50 kg



-6,5°/+12°



STDV100

FLAT SCREEN STAND

1. Modern design with high-end finish
2. Stable and durable aluminium structure
3. Seamless adjustment of screen height
4. Integrated cable management system
5. Can be fixed to the ground

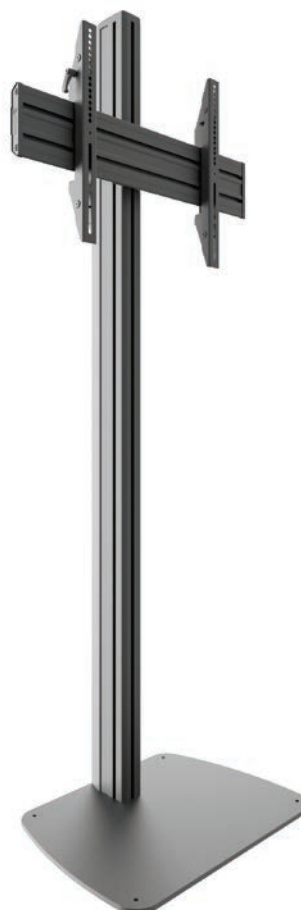

min. 100x100
max. 600x400



40" - 75"



80 kg



11°

Window Facing Display Mounts



The MWDC series of handles for shop windows has been designed and dedicated to window facing displays. The holders have an integrated cable management system and the height adjustment in step, which ensures easy and quick installation.

MWDC series looks always great in every storefront as it attracts viewers' attention, engages them and makes them decide to enter the store and to purchase more often.





min. 100x100
max. 600x400



40"-75"



80 kg



11°



1. Solution dedicated to the window facing displays
2. Mounting to the ceiling
3. Height adjustable
4. Integrated cable management system
5. Quick and easy assembly
6. The offer also includes a floor-mounted option and a ceiling / floor option

Display Mounts

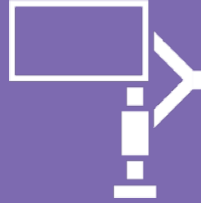

Designed for practical wall mounting of the screen, provides extraordinary functionality with its minimalist design. The ease of installation makes it very simple to use on all types of wall surfaces. Screen protection against falling, robust finish and modern design allow the use of our products in conference rooms, waiting rooms or public areas. Display mounts are a game changer when it comes to dynamic communication where numerous practical matters take a lead.



PWB1

Universal Flat Wall Mount

1. Robust design to ensure load capacity up to 80 kg
2. Lateral adjustment of the screen once mounted on the wall plate
3. Suitable for installation on concrete, plaster and wooden walls



min. 100x100
max. 600x400



40"-75"



80 kg

XWB1

Universal Flat Wall Mount

1. Suitable for mounting large screens up to 110"
2. Suitable for installation on brick, concrete, plaster and wooden walls
3. Wide range of VESA mounting holes



min. 100x100
max. 1200x600



65"-110"



110 kg

FSM100

Universal Flat Wall Mount

1. Screen protection against falling
2. Minimalist design and functionality
3. Simple and quick installation



min. 75x75
max. 400x400



32"-55"



15 kg



FSM150

Universal Tilt Wall Mount

1. Universal mount for screens of different brands
2. Screen tilting from $-10/+5^{\circ}$
3. Quick and simple installation



min. 75x75
max. 400x400



32"-55"



15 kg



VSM653

Double Swing Arm Wall Mount

1. Modern design and aesthetic finish of the wall mount
2. $90^{\circ}/90^{\circ}$ right-left screen rotation
3. Possibility of tilting the screen $+11^{\circ}$



min. 100x100
max. 600x400



$0^{\circ}/+11^{\circ}$



49"-65"



$90^{\circ}/90^{\circ}$



36 kg



VSM654

Double Swing Arm Wall Mount

1. Modern design and aesthetic finish of the wall mount
2. $90^{\circ}/90^{\circ}$ right-left screen rotation
3. Durable aluminium structure



min. 100x100
max. 600x400



$0^{\circ}/+11^{\circ}$



65"-86"



$90^{\circ}/90^{\circ}$



45 kg



RMSA1

Double Swing Arm Wall Mount

1. Option of landscape or portrait
2. Possibility of screen tilting by -10° to $+10^{\circ}$
3. 180° right-left screen rotation



min. 200x400
max. 600x400



$-10^{\circ}/+11^{\circ}$



42"-98"



90°



120 kg



180°



GD04

Tilt Wall Mount

1. Vertical and horizontal adjustment of screen
2. 360° vertical-horizontal screen rotation
3. Lock screw to prevent unauthorised screen removal



min. 75x75
max. 100x100



10 kg



10"-29"



$0^{\circ}/+75^{\circ}$



GDV121

Double Swing Arm Wall Mount

1. Modern design and high-end aesthetics
2. Option of screen tilting by -90° to $+45^{\circ}$
3. Integrated cable management system



min. 75x75
max. 100x100



$-90^{\circ}/+45^{\circ}$



10"-29"



360°



12 kg



$90^{\circ}/90^{\circ}$



Projector Mounts

A solid and safe projector mount is the basis of each audiovisual installation.

The bracket is characterised by a load capacity adjusted to the weight of the device and offers protection against accidental falling out.

It ensures the correct position of the projector in relation to the screen so that the projected image is of the best quality.

The bracket is characterised by the precise and comfortable adjustment of the distance to the wall and the possibility to hide the cables by the integrated cable management system.

Modern design and aesthetics of the projector mount are its unquestionable advantages. The mounts match even the most prestigious interiors.



PMV400

UNIVERSAL PROJECTOR
CEILING MOUNT

1. Micro-Adjustment mechanism ensures precise installation
2. Universal for all key projectors with multiple fixing points
3. Distance from ceiling to projector 143mm



30 kg



143



-25°/+25°

PMV100

UNIVERSAL PROJECTOR
CEILING MOUNT

1. Modern Design with a high-end finish
2. Aluminium construction with a semi-textured powder coat or anodized finish
3. Ceiling plate covers to hide fixings included
4. Micro-Adjustment mechanism ensures precise installation
5. Universal for all key projectors with multiple fixing points
6. Distance from ceiling to projector from 450 mm to 1700 mm
7. Internal cable management in tube 45° horizontal adjustment



30 kg



-7,5°/+7,5°



475-650



-25°/+25°

PMHD115

UNIVERSAL PROJECTOR
CEILING MOUNT

Holder dedicated to heavy projectors

1. Angular and rotational adjustment 0/90
2. Integrated cable management system
3. The telescopic structure allows for quick and convenient adjustment of the distance from the ceiling
4. Available in white and black



60 kg



357-583



-15°/+15°

Kiosks

Multimedia information kiosks make the message way more attractive and keep the recipient's attention much longer than traditional stands.

EDBAK offers info kiosks, outdoor as well as indoor enclosures.

These carriers are used in public spaces, shopping centres and industrial areas.

Kiosk is always a superb solution to attract attention, inform and deliver the news in a dynamic and accessible way.



POK100/POK101

Kiosk for outdoor displays

1. POK100- Dedicated to Samsung monitors: 46OHF, 55OHF
2. POK101-Dedicated to LG monitors: 49XE4F-M, 55XE4F-M
3. Durable steel construction
4. Integrated cable management system
5. Quick and easy assembly



55"-75"

OWM100/ OWM101

Wall enclosure for outdoor displays

1. OWM100- Dedicated to Samsung monitors: 46OHF, 55OHF
2. OWM101-Dedicated to LG monitors: 49XE4F-M, 55XE4F-M
3. Durable steel construction
4. Integrated cable management system
5. Quick and easy assembly



55"-75"

IDS07 Series

INDOOR KIOSK

1. Indoor version for 42"-65" screens
1. Solid steel design
2. Tamper-proof glass
3. Internal ventilation system
4. Easy and simple maintenance
5. Customization possibilities



42"-65"

Bespoke Solutions

Successful business starts with great partners

Edbak shares an extensive business partnership with local and global distributors, integrators as well as each client that requires a reliable product or bespoke solution.

The more demanding, the better.

We are friendly, professional and open to new projects, always ready to discuss Your investment.



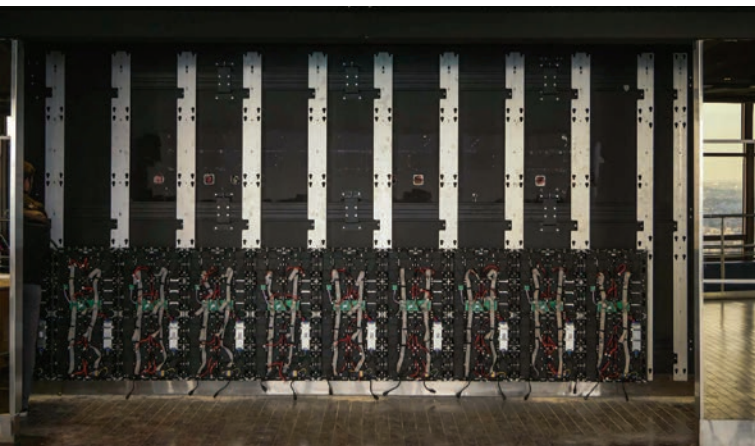

Edbak is much more than ready-made AV products. We share know how and support our business partners with solutions that bring spectacular results. At the end of the day it's all about being flexible, complex and professional when it comes to each project.

The company has its own design office and R&D department where Edbak designers use CAD Autodesk Inventor, SolidWorks and CAM NX-CAM software, delivering a comprehensive and highest quality of service. This, quite often, features truly demanding requests of our clients.

Reliable and solid solutions are never delivered without a proper quality check. Hence Edbak owns its own research and measurement laboratory to fully control the quality of all rendered services. Each product goes through a thorough quality control process.

According to one of our core values, we constantly improve and develop to generate added value.

Our business partners can confirm that Edbak provides **products that communicate the best solutions.**

edbak

EDBAK Sp. z o.o.
Piotrowice 186
23-107 Strzyżewice
Poland
tel. +48 81 562 81 19

www.edbak.com
sales@edbak.com



Let's cooperate.